

# Hydronix

## Hydronix Moisture Sensor Configuration and Calibration Guide

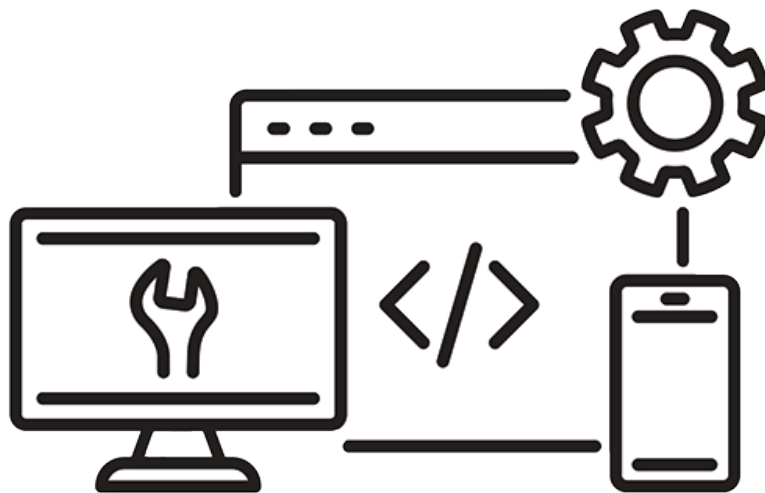

To re-order quote part number:	HD0679
Revision:	1.9.0
Revision date:	September 2024

## Copyright

Neither the whole or any part of the information contained in nor the product described in this documentation may be adapted or reproduced in any material form except with the prior written approval of Hydronix Limited, hereinafter referred to as Hydronix.

© 2024

Hydronix Limited  
Units 11-12, Henley Business Park  
Pirbright Road, Normandy  
Guildford  
Surrey  
GU3 2DX, UK  
United Kingdom

Company Number: 01609365 | VAT Number: GB384155148

All rights reserved

## CUSTOMER RESPONSIBILITY

The customer in applying the product described in this documentation accepts that the product is a programmable electronic system which is inherently complex and which may not be completely free of errors. In doing so the customer therefore undertakes responsibility to ensure that the product is properly installed commissioned operated and maintained by competent and suitably trained persons and in accordance with any instructions or safety precautions made available or good engineering practice and to thoroughly verify the use of the product in the particular application.

## ERRORS IN DOCUMENTATION

The product described in this documentation is subject to continuous development and improvement. All information of a technical nature and particulars of the product and its use including the information and particulars contained in this documentation are given by Hydronix in good faith.

Hydronix welcomes comments and suggestions relating to the product and this documentation

## ACKNOWLEDGEMENTS

Hydronix, Hydro-Probe, Hydro-Mix, Hydro-Skid, Hydro-View and Hydro-Control are Registered Trade Marks of Hydronix Limited

## CUSTOMER FEEDBACK

Hydronix is continually looking to improve not only its products but also the services that we offer to our customers. If you have any suggestions about how we can do this or if you have any other feedback that would be helpful please complete our short form at [www.hydronix.com/contact/hydronix\\_feedback.php](http://www.hydronix.com/contact/hydronix_feedback.php).

If your feedback is concerning an Atex certified product or associated service it would be very helpful for you to give us your contact details and the model number and serial number of the product if possible. This will enable us to contact you with any relevant safety advice should this be necessary. It is not obligatory to leave your contact details and any information will be treated as confidential.

# ***Hydronix Offices***

## **UK Head Office**

Address: Units 11-12 Henley Business Park  
Pirbright Road  
Normandy  
Surrey  
GU3 2DX

Tel: +44 1483 468900

Email: [support@hydronix.com](mailto:support@hydronix.com)  
[sales@hydronix.com](mailto:sales@hydronix.com)

Website: [www.hydronix.com](http://www.hydronix.com)

## **North American Office**

Covers North and South America, US territories, Spain and Portugal

Address: 692 West Conway Road  
Suite 24, Harbor Springs  
MI 47940  
USA

Tel: +1 888 887 4884 (Toll Free)  
+1 231 439 5000

## **European Office**

Covers Central Europe, Russia and South Africa

Tel: +49 2563 4858

## **French Office**

Tel: +33 652 04 89 04



## ***Revision history***

<b>Revision No</b>	<b>Date</b>	<b>Description of Change</b>
1.0.0	Feb 2015	First Release
1.1.0	July 2015	Multi-Mode Calibration Section Added
1.2.0	October 2015	Process for calibrating a sensor in a mixer added
1.2.1	Feb 2016	Minor formatting update
1.3.0	May 2016	Alarm Mode Settings added
1.4.0	July 2016	Calibration material handling updated. Corrected Brix calibration
1.5.0	April 2017	Temperature output scale updated for the HMHT
1.6.0	Nov 2017	Sensor model numbers updated. Filter Include default value changed to -5
1.7.0	June 2021	Filter Include added. Secondary Protocol Added
1.8.0	January 2023	Added Hydro-Probe BX and CA Moisture Probe
1.9.0	September 2024	Ceramic face cleaning information in the diagnostics section specified. Measurement mode selection clarification. Filter Seeding parameter information added. Calibration procedure description revised. Minor format changes



# Table of Contents

Chapter 1 Introduction.....	11
1 Introduction.....	11
Chapter 2 Configuration .....	15
1 Configuring the Sensor.....	15
2 Analogue Output Setup.....	15
3 Digital Inputs/Output Setup .....	17
4 Averaging Parameters.....	19
5 Filtering.....	20
6 Typical Moisture Trace from a Hydronix Moisture Sensor in Flowing Material.....	22
7 Filtering the Signal When Used in a Mixer Application .....	23
8 Measurement Modes.....	25
9 Outputting the Sensor Data.....	27
10 Secondary Protocol .....	28
Chapter 3 Sensor Integration and Material Calibration.....	31
1 Sensor Integration .....	31
2 Introduction to Material Calibration .....	31
3 SSD Coefficient and SSD Moisture Content.....	33
4 Storing Calibration Data .....	33
5 Calibration Procedure for Flowing Material (Linear) .....	34
6 Linear Calibration .....	37
7 Quadratic Calibration.....	37
8 Calibrating a sensor in a mixer.....	38
9 Brix Calibration .....	40
Chapter 4 Best Practices .....	43
1 General to all Applications .....	43
Chapter 5 Sensor Diagnostics .....	45
1 Sensor Diagnostics .....	45
Chapter 6 Frequently Asked Questions .....	51
Appendix A Document Cross Reference .....	53
1 Document Cross Reference.....	53





## **Table of Figures**

Figure 1: Connecting the Sensor (Overview).....	13
Figure 2: Guidance for Setting Output Variable.....	15
Figure 3: Raw and Filter Include Sensor Output.....	21
Figure 4: Raw Unscaled Moisture Trace in Flowing Material .....	22
Figure 5: Graph showing the Filtered Signal.....	23
Figure 6: Typical Moisture Curve .....	23
Figure 7: Graph showing Raw Signal during Mix Cycle.....	24
Figure 8: Filtering the RAW Unscaled Signal (1).....	24
Figure 9: Filtering the RAW Signal (2) .....	25
Figure 10: Relationship of Unscaled Values to Moisture .....	26
Figure 11: Data arrangement in the sensor .....	27
Figure 12: None specified Output Selection .....	28
Figure 13: Legacy Output Selection.....	28
Figure 14: Calibrations for 3 Different Materials .....	31
Figure 15: Typical Calibration Results .....	32
Figure 16: Calibration inside the Sensor.....	33
Figure 17: Calibration inside the Control System.....	34
Figure 18: Example of Good Material Calibration.....	37
Figure 19: Examples of Poor Material Calibration Points .....	37
Figure 20: Example of a Good Quadratic Calibration .....	38
Figure 21: Example of a Bad Quadratic Calibration .....	38
Figure 22: Example of a Good Brix Calibration.....	41
Figure 23: Example of a Bad Brix Calibration .....	42



## 1 Introduction

This Configuration and Calibration Guide is valid for the following Hydronix sensors only:

Hydro-Probe	(Model number HP04 onwards)
Hydro-Probe XT	(Model number HPXT02 onwards)
Hydro-Probe Orbiter	(Model number ORB3 onwards)
Hydro-Probe SE	(Model number SE03 onwards)
Hydro-Mix	(Model number HM08 onwards)
Hydro-Mix HT	(Model number HMHT01 onwards)
Hydro-Mix XT	(Model number HMXT01 onwards)
Hydro-Probe BX	(Model number HPBX01 onwards)
CA Moisture Probe	(Model number CA0022)

User guides for other model numbers are available from [www.hydronix.com](http://www.hydronix.com).



Hydronix Microwave Moisture sensors use high speed digital signal processing filters and advanced measurement techniques. This gives a signal which is linear with the change in moisture in the material being measured. The sensor must be installed into a material flow and will then give an online output of the moisture change in the material.

Typical applications include moisture measurement in Sand, Aggregates, Concrete, Biomass materials, Grain, Animal feed and Agricultural materials.

The sensors are designed to operate in various applications and have been created to allow the material to flow past the sensor. The following are examples of typical applications.

- Bins / Hoppers / Silos
- Conveyors
- Vibratory Feeders
- Mixers

The sensor has two analogue outputs which are fully configurable and can be internally calibrated to give a direct moisture output which is compatible with any control system.

Two digital inputs are available which can control the internal averaging function. This allows the sensor measurement, which is taken at 25 times per second, to enable rapid detection of any changes in moisture content to be averaged. This facilitates easier use in the control system.

One of the digital inputs can be configured to provide a digital output which can provide an alarm signal in the event of a low or high reading. This can be used to signal a high moisture alarm or alternatively to signal an operator that a storage bin needs to be refilled.

Hydronix sensors are specially designed using suitable materials to provide many years of reliable service even in the most arduous conditions. However, as with other sensitive electronic devices, care should be taken not to subject the sensor to unnecessary impact damage. Care should be paid to the ceramic faceplate which, whilst being extremely resistant to abrasion, is brittle and may be damaged if hit directly.

#### **CAUTION – NEVER HIT THE CERAMIC**



Care should be taken to ensure that the sensor has been correctly installed and in such a manner to ensure representative sampling of the material concerned. It is essential that the sensor is installed in a location where the ceramic faceplate is fully inserted into the main flow of the material. It must not be installed in motionless material nor where material can build-up on the sensor.

All Hydronix sensors are pre-calibrated in the factory so that they read 0 when in air and 100 when submerged in water. This is called the 'Unscaled Reading' and is the base value used when calibrating a sensor to the material being measured. This standardises each sensor, so if a sensor is changed then there is no need to redo the material calibration.

After installation, the sensor should be calibrated to the material (see Chapter 3 for more details). The sensor can be setup in two ways:

- *Calibration inside sensor:* Sensor is calibrated internally and outputs true moisture.
- *Calibration inside control system:* Sensor outputs an unscaled reading which is proportional to moisture. Calibration data inside the control system converts this to true moisture.

## 2 Measuring Techniques

The sensor uses the unique Hydronix digital microwave technique that provides a more sensitive measurement compared to analogue techniques. This technique facilitates a choice of measurement modes (not available in all sensors, see relevant sensors installation guide for technical specifications). The default mode is F Mode which is suitable for all material but particularly sand and aggregates. For more information about which mode to select please contact Hydronix: support@Hydronix.com

## 3 Sensor Connection and Configuration

The moisture sensor may be remotely configured using a digital serial connection and a PC running Hydro-Com sensor configuration and calibration software. For communication with a PC, Hydronix supply RS232-485 converters or a USB Sensor Interface Module (See User Guide HD0303)

**Note: All references to Hydro-Com in this user guide refer to software version 2.0.0 and higher. The sensor can be configured using older versions of Hydro-Com however some features will not be available. See the relevant Hydro-Com user guide for more details.**

There are two basic configurations for connecting the sensor to a batch control system:

- Analogue output – A DC output is configurable to:
  - 4-20 mA
  - 0-20 mA
  - 0-10 V output can be achieved using the 500 Ohm resistor supplied with the sensor cable.
- Digital – an RS485 serial interface permits direct exchange of data and control information between the sensor and the plant control computer. USB and Ethernet adapter options are also available.

The sensor can be configured to output a linear value of between 0-100 unscaled units with the material calibration being performed in the control system. Alternatively, it is also possible to internally calibrate the sensor to output a real moisture value.

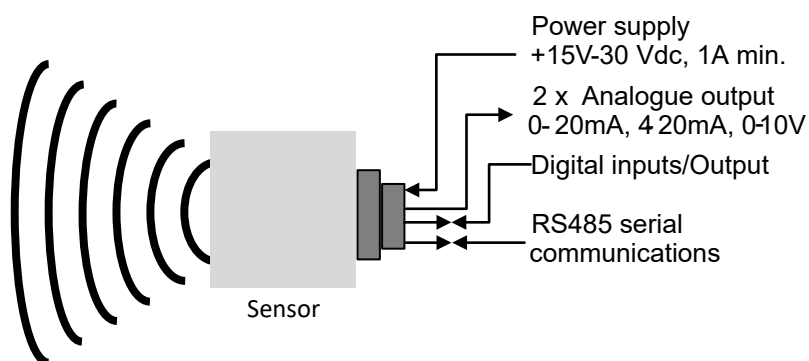

Figure 1: Connecting the Sensor (Overview)



## 1 Configuring the Sensor

The Hydronix microwave moisture sensor has several internal parameters which can be used to optimise the sensor for a given application. These settings are available to view and change using the Hydro-Com software. Information for all settings can be found in the Hydro-Com User Guide (Hydro-Com User Guide HD0682).

Both the Hydro-Com software and the Hydro-Com user guide can be downloaded free of charge from [www.hydronix.com](http://www.hydronix.com).

All Hydronix sensors work in the same way and use the same configuration parameters. However, not all the functions are used in every sensor application. (Averaging parameters, for example, are typically used for batch processes).

## 2 Analogue Output Setup

The working range of the two current loop outputs can be configured for the equipment it is connected to, for example a PLC may need 4 – 20 mA or 0 – 10V DC. The outputs can also be configured to represent different readings generated by the sensor e.g. moisture or temperature.

Figure 2 may be used to assist in selecting the correct analogue output variable for a given system.

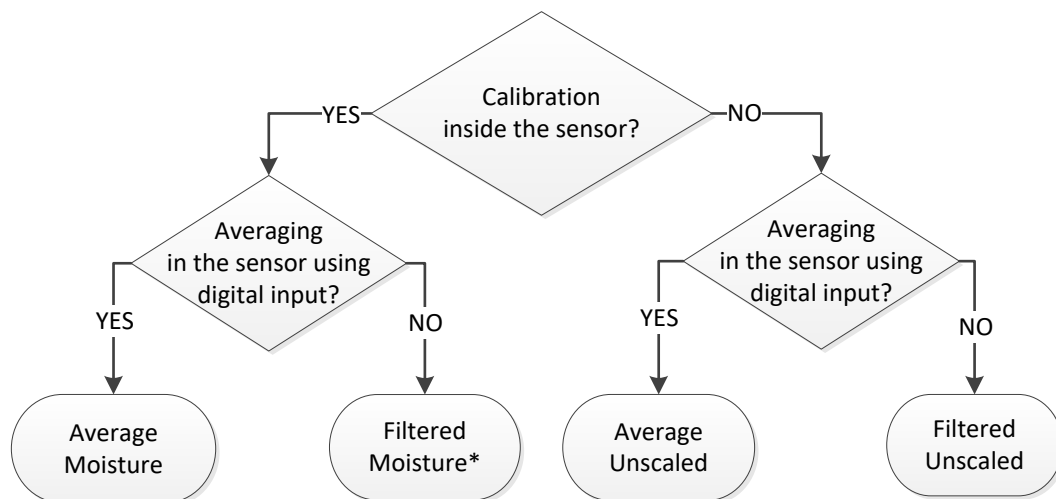

\*It would be advisable to average in the control system here

**Figure 2: Guidance for Setting Output Variable**

### 2.1 Output Type

This defines the type of the analogue outputs and has three options:

- 0 – 20mA: This is the factory default. The addition of an external 500 Ohm precision resistor converts the 0-20mA to 0 – 10V DC.
- 4 – 20mA.

### 2.2 Output Variable 1 and 2

These define which sensor readings the analogue output will represent and has 10 options.

### 2.2.1 Raw Unscaled

This is the raw unfiltered unscaled variable. A Raw Unscaled value of 0 is the reading in air and 100 would relate to a reading in water. As no filtering is applied to this variable it should not be used for process control. This output can be used for logging during initial sensor installation.

### 2.2.2 Raw Unscaled 2

If set this will output the alternative measurement mode as configured for the sensor (see Chapter 2 Section 8 for more information about alternative measurement modes). No filtering will be applied.

**Note: This mode is not available in all sensors please see the technical specification in the relevant installation guide for more details.**

### 2.2.3 Filtered Unscaled

Filtered Unscaled represents a reading which is proportional to moisture and ranges from 0 – 100. An unscaled value of 0 is the reading in air and 100 would relate to a reading in water.

### 2.2.4 Filtered Unscaled 2

The Filtered Unscaled uses the second measurement mode configured in the sensor.

**Note: This mode is not available in all sensors. Please see the technical specification in the relevant installation guide for more details.**

### 2.2.5 Average Unscaled

This is the 'Raw Unscaled' variable processed for batch averaging using the averaging parameters. To obtain an average reading, the digital input must be configured to 'Average/Hold'. When this digital input is activated, the Raw Unscaled readings are averaged. When the digital input is low, this average value is held constant.

### 2.2.6 Filtered Moisture %

The Filtered Moisture % is scaled using the Filtered Unscaled value using the A, B, C and SSD coefficients.

$$\text{Filtered Moisture \%} = A \times (\text{F.U/S})^2 + B \times (\text{F.U/S}) + C - \text{SSD}$$

These coefficients are derived solely from a material calibration and so the accuracy of the moisture output is dependent upon the accuracy of the calibration.

The SSD coefficient is the Saturated Surface Dry offset (Water Adsorption Value) for the material in use and allows the displayed percentage moisture reading to be expressed in surface (free) moisture only.

### 2.2.7 Raw Moisture %

This is the Raw Moisture % variable before any filtering or averaging. As Filtering has not been applied it is not recommended to use this variable for process control.

### 2.2.8 Average Moisture %

This is the 'Raw Moisture %' variable processed for batch averaging using the averaging parameters. To obtain an average reading, the digital input must be configured to





(Unscaled or moisture). When the input is activated, the analogue output will indicate the material temperature (in degrees centigrade).

Temperature scaling on the analogue output is fixed – zero scale (0 or 4mA) corresponds to 0°C and full scale (20mA) to 100°C.

**Mixer Sync:** A new synchronised measurement cycle is started when the input goes active.

The second digital input/output can be set as an input for Moisture/Temperature but can also be set to the following outputs:

**Bin Empty:** This output is activated if the Unscaled or Moisture values go below the Low Limits defined in the Averaging section. This can be used to signal to an operator when the sensor is in air (as the sensor's value goes to zero in air) and can indicate a vessel empty state.

**Data out of range:** The output will be active if the moisture reading is above or below the moisture include limits or the Unscaled is above or below the Unscaled include limits.

**Sensor OK:** This output will be active if:

- The frequency reading is between the defined air and water calibration points +/-3%
- The amplitude reading is between the defined air and water calibration points +/-3%
- The temperature of the internal electronics is below the safe operating limit.
- The temperature of the RF resonator is above its safe operating limit.
- The internal supply voltage is in range.

**Material Temp alarm:** The alarm will be active if the material temperature is outside the configured high/low limits.

**Calibration out of range:** The output will be active if the Unscaled reading, for any of the measurement modes, is more than 3 points above or below the range of Unscaled values used in the calibration. This can be used to indicate that another calibration point could/ should be made.

**Auto-Track Stable:** Auto-Track Stable indicates if the sensor reading is stable. The stability is defined as the deviation of a set amount of data points. Both the deviation value and the amount of data used, in seconds, are configurable in the sensor. The output will be active if the Auto-Track Deviation is below the Auto-Track Deviation threshold.

**Filter Include:** Filter Include is used to control when the signal filters are applied to the Raw signals. When the input is active, the signal filters are applied to the Raw signals. When the input is deactivated, the last filtered value is held constant. When the input is activated again, the filtering will commence starting from the previously held value (see section 5.5 Filter Seeding for more info).

**Average Hold:** Duplicate of the first digital input.

## 3.2 Inputs/Output Configuration Settings

### 3.2.1 High Limit and Low Limit (Alarms)

The High Limit and Low Limit may be set for both the moisture % and the sensor Unscaled value. The two parameters operate independently. The Bin Empty output will activate when the reading is below the Low Limit. The Data Invalid output will activate when the reading is above the High Limit or below the Low Limit.

### 3.2.2 Material Temperature High and Low limits (Alarm)

The Material High and Low Limits are used to configure the Material Temperature alarm. If Digital Input/Output 2 is set to Material Temperature Alarm the output will become active if the material temperature sensor is above the high limit or below the low limit.

### 3.2.3 Auto-Track Deviation Threshold

The Auto-Track Deviation Threshold is used to configure the Auto-Track Stable alarm. The output if configured will become active if the deviation of the Filtered Unscaled reading is below this limit.

### 3.2.4 Auto-Track Time

The Auto-Track Time sets the amount of data, in seconds, that is averaged to calculate the Auto-Track deviation.

### 3.2.5 Alarm Mode

Configures which Measurement Mode (Mode F, Mode V, Mode E or Legacy) is used to calculate the alarm values. The Alarm Mode is only available for sensors with multi measurement mode capabilities. Once configured, the sensor will only calculate the alarm values using the selected measurement mode. The Alarm Mode will also configure which mode is used to calculate the Auto-Track values.

## 4 Averaging Parameters

During averaging the sensor uses the Raw or Filtered Unscaled value (user configured) in its calculations. The following parameters determine how the data is processed for batch averaging when using the digital input or remote averaging. They are not normally used for continuous processes.

### 4.1 High Limit and Low Limit

The High Limit and Low Limit may be set for both the moisture % and the Unscaled value. The two parameters operate independently. If the sensor reading falls outside of these limits during sensor averaging the data will be excluded from the average calculation.

***This is configured using the High / Low limits in the Input/Output configuration (section 3.2.1).***

### 4.2 Average/Hold Delay

When using the sensor to measure the moisture content of a material as it is discharged from a bin or silo, there is frequently a short delay between the control signal issued to begin the batch and the material beginning to flow over the sensor. Moisture readings during this time should be excluded from the batch average value as they are likely to be unrepresentative static measurements. The 'Average/Hold' delay value sets the duration of this initial exclusion period. For most applications 0.5 seconds will be adequate but it may be desirable to increase this value. Options are: 0, 0.5, 1, 1.5, 2 and 5 seconds.

### 4.3 Averaging Mode

Sets the averaging mode used when calculating the average. The modes available are, 'Raw' (Unscaled/Moisture) and 'Filtered' (Unscaled/Moisture). For applications where mechanical apparatus, such as mixer paddles or screws, pass over the sensor and affect the reading the use of the 'Filtered' value will remove the peaks and troughs in the signal. If the material flow is stable, for example, when measuring at the output from a silo, the averaging should be set to 'Raw'.

## 5 Filtering

***Default filtering settings can be found in the relevant sensor default settings engineering note, see Appendix A Document Cross Reference for details.***

The Raw Unscaled reading is measured 25 times per second and may contain a high level of 'noise' due to irregularities in the signal as the material flows. As a result, this signal requires a certain amount of filtering to make it usable for moisture control.

The default filtering settings are suitable for most applications; however, they can be customised if required to suit the application.

It is not possible to have default filtering settings that are ideally suited to all applications because each will have distinctive characteristics. The ideal filter is one that provides a smooth output with a rapid response.

The Raw Moisture % and Raw Unscaled settings should **not** be used for control purposes.

The Raw Unscaled reading is processed by the filters in the following order; first the Slew Rate Filters limit any step changes in the signal, then the Digital Signal Processing Filters remove any high frequency noise from the signal and finally the smoothing filter (set using the Filtering Time function) smooths the whole frequency range.

Each filter is described in detail below.

### 5.1 Slew Rate Filters

The Slew Rate Filters are useful for clipping large peaks or troughs in the sensor reading caused by mechanical interference in a process.

The filters set rate limits for large positive and negative changes in the raw signal. It is possible to set limits for positive and negative changes separately. Options are: None, Light, Medium and Heavy. The heavier the settings the more the signal will be 'clipped' and the slower the signal response.

### 5.2 Digital Signal Processing

The Digital Signal Processing Filters (DSP) remove excessive noise from the signal using an advanced algorithm. The filter reduces high frequency noise. The advantage of this filter is that the DSP filter will treat all signals within a meaningful frequency range as valid. The result is a smooth signal that responds rapidly to changes in moisture.

DSP filters are particularly useful in high noise applications such as a mixing environment. They are less appropriate for low noise environments.

Options are: None, Very Light, Light, Medium, Heavy and Very Heavy.

### 5.3 Filtering Time (Smoothing Time)

The Filtering Time smooths the signal after it has first passed through the Slew Rate filters and then the DSP filters. This filter smooths the whole signal and will therefore slow the signal response. The Filtering Time is defined in seconds.

Options are: 0, 1, 2.5, 5, 7.5, 10 and a custom time of up to 100 seconds.

### 5.4 Filter Include

When set, only Unscaled values above the set point will be included in the filtered output. Set to a low value to include all measurements. The default value is -5.

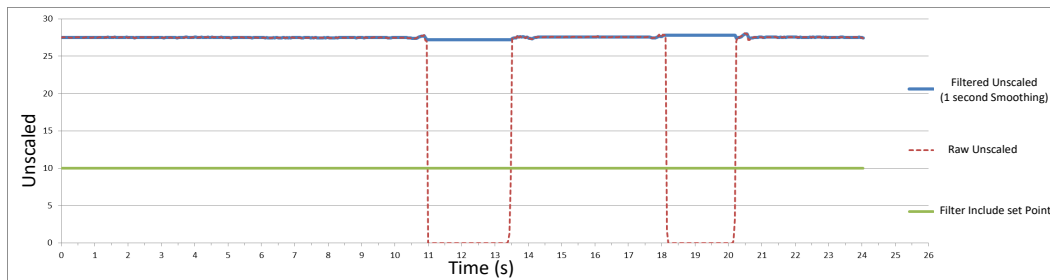

Figure 3: Raw and Filter Include Sensor Output

### 5.5 Filter Seeding

The Filter Seeding parameter works in conjunction with the Filter Include function. The setting dictates whether the filtered output restarts from the last known filtered or the last known raw value, after the raw signal rises above the set point (set by the Filter Include parameter).

Options are: Last Filtered Value, Last Raw Value. The default value is Last Filtered Value.

When the digital input is set to Filter Include the following functionality is observed

Filter Seeding Setting	Digital Input State	Functionality
Last Filtered Value	Active	Updates Filtered Unscaled
Last Filtered Value	Inactive	Filtered Unscaled when input deactivated is displayed
Last Filtered Value	Inactive	Filtered Unscaled when input deactivated is displayed
Last Raw Value	Active	Updates Filtered Unscaled
Last Raw Value	Inactive	Outputs Raw Unscaled

Table 1 - Filtered Unscaled output functionality

## 6 Typical Moisture Trace from a Hydronix Moisture Sensor in Flowing Material

Figure 4 is a typical Raw Unscaled trace of a flowing material. The signal is erratic due to the action of the material flowing past the sensor.

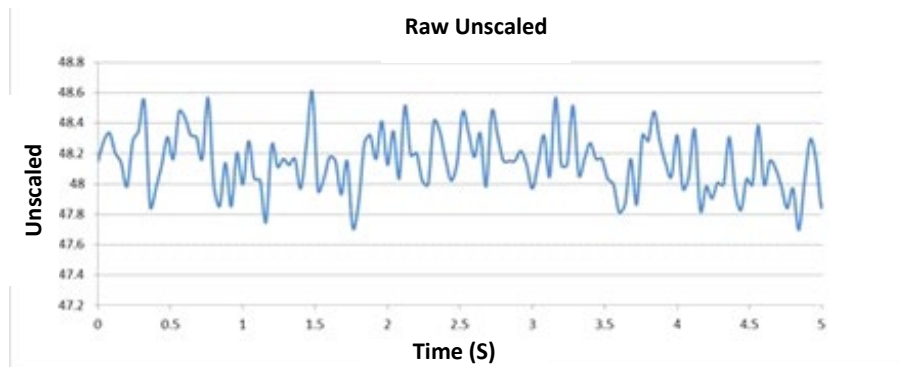

**Figure 4: Raw Unscaled Moisture Trace in Flowing Material**

The positive peaks and negative troughs can be clipped using the Slew Rate Filters reducing unwanted noise. After the signal has been through the Slew Rate Filters, and if selected the DSP filter, the signal is smoothed further using the Filtering Time (Smoothing Time). The result is a much clearer representation of the moisture in the material (Figure 5).

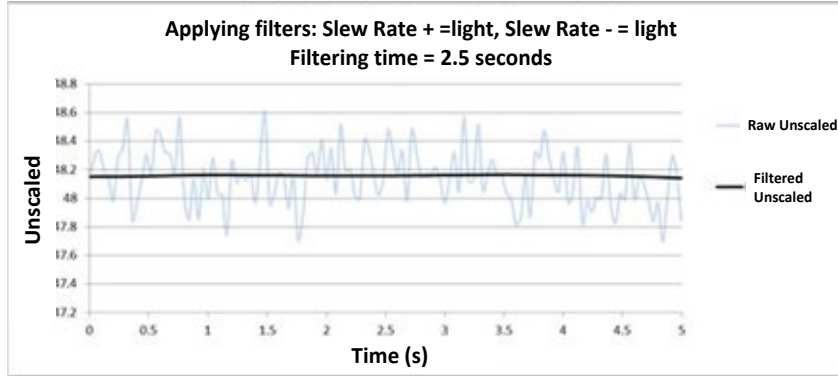

Figure 5: Graph showing the Filtered Signal

## 7 Filtering the Signal When Used in a Mixer Application

Due to high levels of noise caused by the mixer blades, the signal will require a certain amount of filtering to make it usable for moisture control. The default settings are suitable for most applications however they can be customised if required.

It is not possible to have default filtering settings that are ideally suited to all mixers because every mixer has a different mixing action. The ideal filter is one that provides a smooth output with a rapid response.

Figure 6 is a typical moisture curve during a batching cycle of concrete. The mixer starts empty and as soon as material is loaded, the output rises to a stable value, Point A. Water is then added and the signal rises and stabilises at Point B. The batch is completed, and the material is discharged. Stability in the readings at points A and B signify that all the ingredients within the mixer are homogeneously mixed.

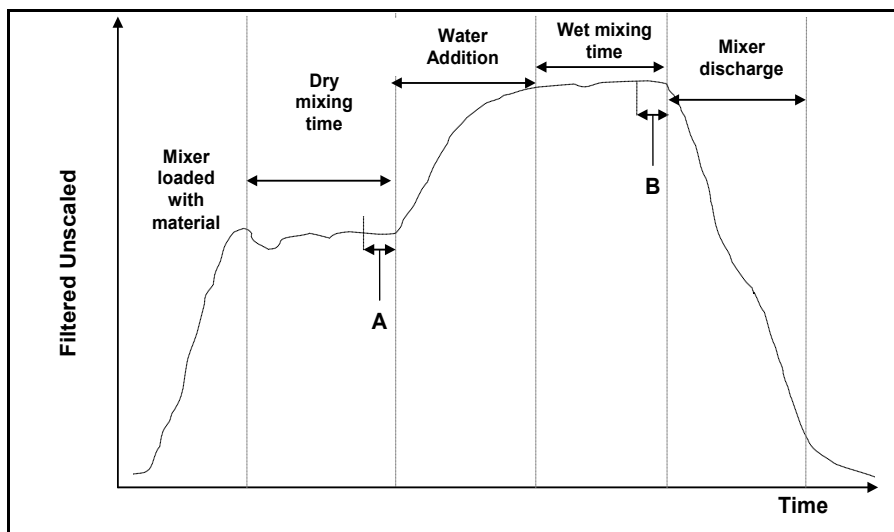
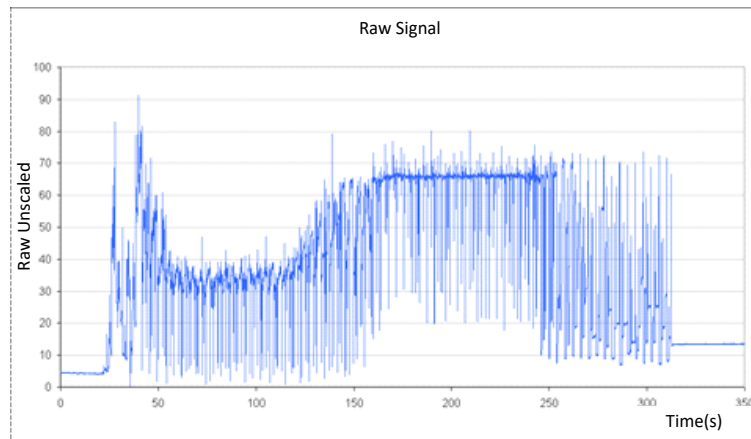

Figure 6: Typical Moisture Curve

The degree of stability at points A and B can have a significant effect on accuracy and repeatability. Most automatic water controllers measure the dry moisture and calculate the amount of water to add to the mix based on a known final reference in a particular recipe. It is vital to have a stable signal in the dry mix phase of the cycle at point A. This enables the water controller to take a representative reading and make an accurate calculation of the water required to be added. For the same reasons, stability at the wet end of the mix (Point B) will give a representative final reference indicating a good mix when calibrating a recipe.

Figure 7, shows the Raw Unscaled data recorded from a sensor over an actual mix cycle, clearly indicating the large peaks and troughs caused by the mixing blade action.



**Figure 7: Graph showing Raw Signal during Mix Cycle**

The following two graphs illustrate the effect of filtering the same raw data shown above. Figure 8 shows the effect of using the following filter settings which create the 'Filtered Unscaled' line on the graph.

Slew-Rate + = Medium  
 Slew-Rate - = Light  
 Filtering Time = 1 second

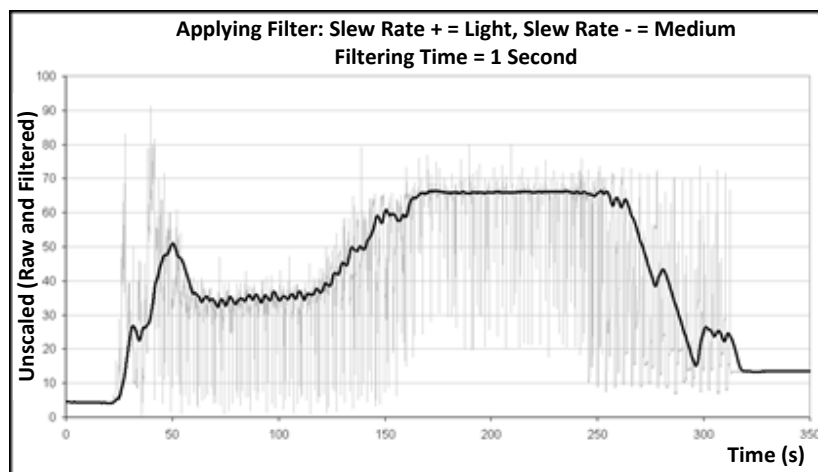
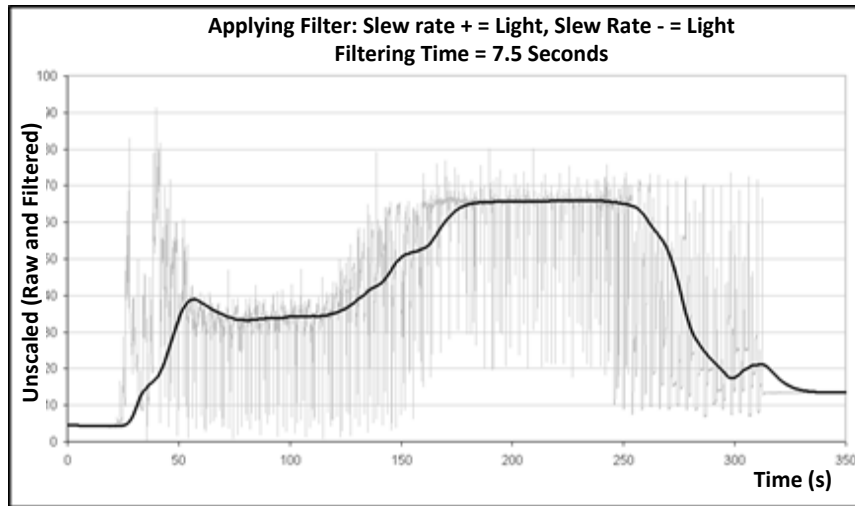

**Figure 8: Filtering the RAW Unscaled Signal (1)**

Figure 9 shows the effect of the following settings:

Slew-Rate + = Light  
 Slew-Rate - = Light  
 Filtering Time = 7.5 seconds





**Figure 9: Filtering the RAW Signal (2)**

In Figure 9 it is clear that the signal at the dry phase of the mix cycle is more stable which is more advantageous when making the water calibration.

The default filter settings are suitable for most applications. However, to determine the optimal settings it is advisable to monitor the results during initial commissioning to balance noise reduction with the speed of response.

## 8 Measurement Modes

Measurement Modes enable the sensitivity of the sensor to be optimised for a given material.

Selection of Measurement Modes is not available in all sensors and different models will have different default Measurement Mode settings. Refer to the technical specification section in the relevant sensor installation guide for further information.

Up to three Measurement Modes are available: Mode F, Mode V and Mode E.

Selecting the most appropriate mode can have the effect of increasing the precision in the reading but may limit the highest moisture value measurable by the sensor.

The sensor continuously calculates the Unscaled value in each of the available modes (F, V and E). It is important to note that the sensor does not work in a particular mode, but rather in all modes all the time. Any material or process will have an optimum mode of operation selectable by the operator.

### 8.1 Selecting which Measurement Mode to Use

The most appropriate mode will be determined by the requirements of the user, the application and the material being measured.

Precision, stability and density fluctuations as well as the working moisture range are all factors that may determine the choice of measurement mode.

For most applications, Mode F provides a suitable balance of stability and sensitivity.

For applications where the change in Unscaled (US) is small over the working range of moisture, Mode V or Mode E may provide a more sensitive response. It should be noted that Mode V and Mode E might produce less stable measurement, and changes to filter settings may be required.

Mode Vand E, whilst they may offer more sensitivity, will saturate at a lower moisture level and may be unsuitable for applications with higher moisture contents.

In most applications, Mode F will provide the most stable measurement of all the modes. However, occasionally, the analysis of the modes may show that other modes provide more stable measurement. This can be determined by logging each mode at a raw log rate and comparing the stability of each mode.

## 8.2 Effects of Selecting Different Modes

Each mode will give a different relationship between the sensor's 0-100 Unscaled values and the moisture percentage.

When measuring in any material it is usually beneficial that a large change in sensor Unscaled measurement equates to a small change in moisture levels. This will give the most precise calibrated moisture measurement (see Figure 10). This assumes that the sensor remains capable of measuring across the full moisture range required and that the sensor is not configured to be impractically overly sensitive.

All modes will give a linear stable output. The objective is to choose the mode that displays the flattest moisture calibration line as shown by line B in Figure 10. It should be noted that whilst line B is more precise, the maximum 100 Unscaled units may be reached at a lower moisture % than the expected maximum moisture of the material being measured. The exact highest moisture % achievable is a function of the gradient of the material calibration and must be determined by the user.

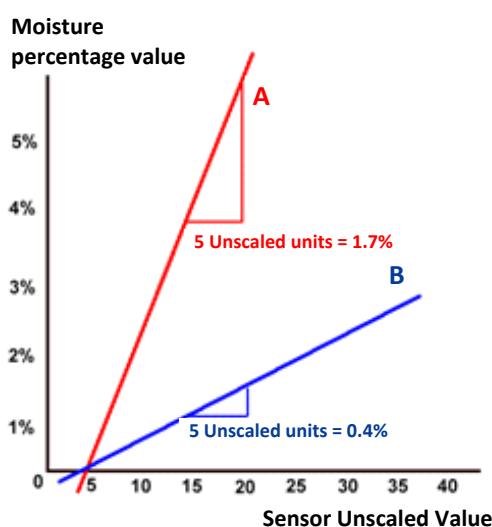

**Figure 10: Relationship of Unscaled Values to Moisture**

To determine which mode is the most appropriate it is recommended to run trials for a given material, mixer type or application. Before doing so it is recommended that you contact Hydronix to seek advice on our recommended settings for your given application.

Trials differ dependent upon the application. For a measurement taken over time it is recommended to record the sensor's output from each of the different measurement modes in the same process. Data can easily be recorded using a PC and the Hydronix Hydro-Com software; these results may then be plotted to ascertain the most suitable measurement mode.

For further analysis, including sensor filtering analysis Hydronix can also offer advice as well as software to enable the experienced user to achieve the best possible settings for a sensor.

Hydro-Com software and the user guide may be downloaded from [www.hydronix.com](http://www.hydronix.com).

When using the sensor to obtain an output signal that is calibrated to moisture (an absolute moisture measurement) it is recommended to calibrate using the different measurement modes and to compare results (see Chapter 3 for more details).

For further information please contact the Hydronix support team at [support@hydronix.com](mailto:support@hydronix.com)

## 9 Outputting the Sensor Data

The sensor stores data for all modes and so the selection of the mode to be used is made when the output variable is chosen. This is now part of the process of optimising the sensor operation for the material being measured.

The diagram below shows the arrangement of the data within the sensor:

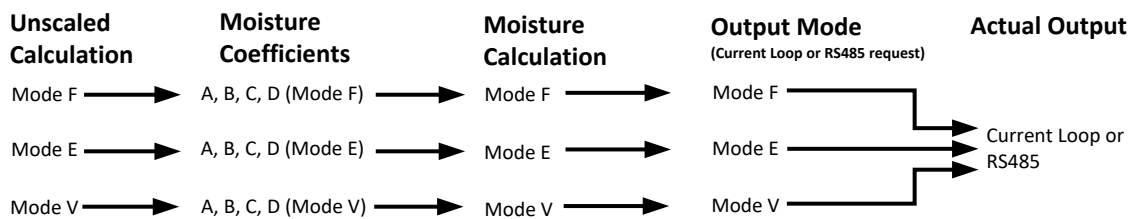

Figure 11: Data arrangement in the sensor

### 9.1 Analogue Current Loops

If the data is to be output using the analogue current loop, then in addition to selecting the Unscaled or Moisture output the user will select which mode to use. For example, analogue output 1 might be set to “Filtered Unscaled Mode F” or “Average Moisture Mode E”.

### 9.2 RS485 Protocol

The Hydronix Hydro-Link protocol has been extended to allow data for different modes to be requested. Using the extended protocol the host might request “Average Unscaled Mode V” or “Filtered Unscaled Mode E” for example. A full protocol specification is available by request from Hydronix for users wishing to implement the Hydro-Link protocol in a control system.

### 9.3 Backwards Compatibility with Older Host Systems

For new host system implementations, the scheme described above (Figure 11) provides optimum performance and flexibility to determine and select the most appropriate mode for any given material. It is recommended that any new implementations support this scheme.

Many sensors will be connected to older Legacy systems and some additions to the scheme have been made to support these and provide compatibility. These Legacy sensors worked in one of the modes, pre-determined and set with the Unscaled 1 Type parameter. They also supported only one set of A, B, C and D calibration coefficients.

Sensors using HS0102 firmware have implemented a slightly expanded scheme to remain backwards compatible. If the current loop output variable or Hydro-Link protocol request is made without specifying a mode (as would be done by older host systems) then the Unscaled 1 type setting comes into effect. The relevant mode to output would be selected by the Unscaled 1 Type. This extends the diagram as shown:

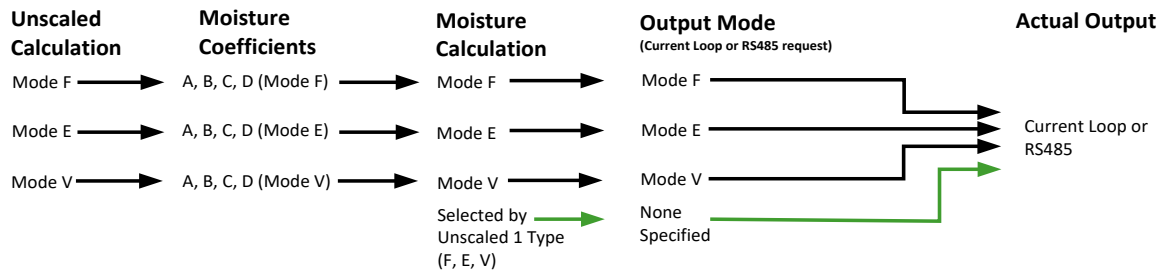

**Figure 12: None specified Output Selection**

As older host applications are unable to write the A, B, C and D coefficients for each of the modes, a final extension is made that supports a set of Legacy Mode coefficients which are supported by existing host systems. This is shown in the final version of the diagram:

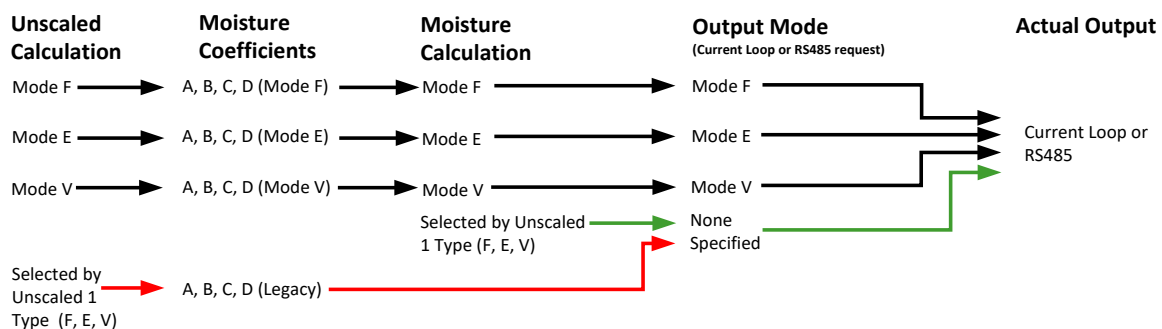

**Figure 13: Legacy Output Selection**

If a current loop output is set without a Mode specifier or an RS485 protocol request is made without a Mode specifier (for a Moisture value):

- If the Legacy Coefficients are non-zero these coefficients are used to calculate the Moisture value. (Red arrows in the diagram)
- If the Legacy Coefficients are all zero, then the Unscaled 1 Type is used to select the relevant coefficients and Moisture (Green arrows). This enables a sensor to be fully calibrated on a current host system in all modes and operated on a legacy host system.

## 9.4 Unscaled 2

In Legacy sensor products a second Unscaled calculation was implemented to allow the comparison of two modes at the same time. This allowed Unscaled readings for a second mode to be output, but not Moisture readings. Unscaled 2 has been implemented in the latest sensors for backwards compatibility, but as these sensors calculate all the modes all the time it should not be used for new host system implementation.

In the latest sensors, multiple RS485 protocol requests can be made to compare modes, or the two analogue current loop outputs can be configured for different modes.

## 10 Secondary Protocol

Sensors using firmware HS0102 v1.11.0 and above have the option to communicate using Modbus RTU protocol. This is in addition to the default Hydro-Link RS485 protocol. The same electrical connection is used for both Hydro-Link and Modbus RTU messages; however, only one type of protocol message can be processed at a time.

The secondary protocol is configured separately, this enables it to have different communication settings compared to the default protocol (Address, Baud and Parity).

For full details on the Modbus communication registers see: Hydronix Microwave Moisture Sensor Modbus RTU Protocol Register Mapping HD0881

## 10.1 Modbus Configuration

To enable the sensor to accept Modbus RTU commands, the secondary protocol must be activated, and the communication settings must match the control system configuration. Hydro-Com software HS0099 v1.11.0 and above must be used to configure the sensor for Modbus RTU.

The configuration options and the default values are as follows:

Configuration Setting	Default	Options
Secondary Protocol	Modbus	None Modbus
Baud	19200	2400 4800 9600 19200 38400 57600 115200
Address	1	1-247
Parity	None	None 1 Stop Bit None 2 Stop Bits Odd Even

Table 2: Modbus Configuration



## 1 Sensor Integration

The sensor may be integrated into a process in one of three ways:

- The sensor may be configured to output a linear value of between 0-100 Unscaled units with a material calibration being performed in an external control system.

*Or*

- The sensor may be internally calibrated using the Hydro-Com sensor configuration and calibration software to output an absolute moisture percentage value.

*Or*

- The sensor could also be used to output a target value.

Software development tools are available from Hydronix for system designers who wish to develop their own interface.

**For full details about how to integrate the sensor into a control system or process see document EN0077 'Moisture control methods for batching'.**

## 2 Introduction to Material Calibration

### 2.1 The “Unscaled” Value

When it is manufactured, each sensor is individually calibrated in a controlled environment so that a zero (0) value relates to the measurement in air and 100 relates to water. This is used to give a raw output value from a Hydronix sensor which ranges from 0 to 100 and is called the Unscaled value.

### 2.2 Why Calibrate?

Hydronix Microwave Moisture Sensors measure the electrical properties of a material. Each material has its own unique electrical characteristics and as a result a calibration process must be performed to output a true moisture/Brix value. As the moisture in a material varies the sensor detects the changes and the Unscaled value is adjusted accordingly. Due to every material having a different electrical property the Unscaled value at a certain moisture % will result in a different Unscaled value for each material.

Figure 14: Calibrations for 3 Different Materials shows the calibration line for three different materials. For each material when the Unscaled value is at 20 the corresponding Moisture % is different. For material A an Unscaled value of 20 corresponds to a moisture of 15%. At the same Unscaled value for Material B the moisture is 10%.

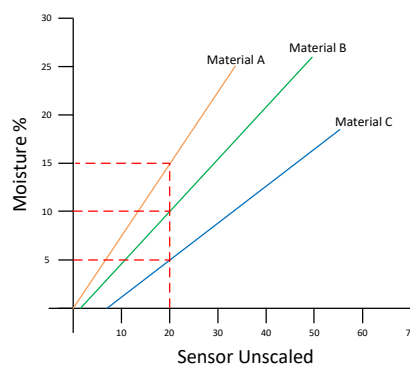

**Figure 14: Calibrations for 3 Different Materials**

A sensor material calibration correlates the Unscaled value to a 'real' moisture (Figure 15). This correlation is determined by measuring the Unscaled value of a material at various moisture or Brix contents and collecting a sample of the material. The moisture in the sample is determined using an accurate laboratory process. The full recommended process is detailed in this user guide.

Sensor Unscaled	Laboratory Moisture Result
10	5
20	10
30	15
40	20

Figure 15: Typical Calibration Results

## 2.3 Material Changes

It is important to position the sensor where there is an adequate and consistent flow of material. Fluctuations in the composition of the material such as varying blends, density or compaction may adversely affect the validity of the calibration. See the Installation guide for the appropriate sensor for mounting advice.

For further advice regarding specific applications please consult the Hydronix support team [support@hydronix.com](mailto:support@hydronix.com)

## 2.4 The Calibration Types

Hydronix Microwave Moisture Sensors can be calibrated using several different methods.

### Linear:

A material calibration for moisture is normally linear, and calibrating to this is described on page 34. The following equation is used:

$$\text{Moisture \%} = B \times (\text{Unscaled Reading}) + C - \text{SSD}$$

### Quadratic:

There is also a quadratic function for use in the rare cases when the measurement of the material exhibits non-linear characteristics, a quadratic term can be used in the calibration equation as shown below.

$$\text{Moisture \%} = A \times (\text{Unscaled reading})^2 + B (\text{Unscaled reading}) + C - \text{SSD}$$

Use of the quadratic coefficient (A) would only be necessary in complex applications and for most materials the calibration line will be linear in which case 'A' is set to zero.

### Brix:

Selected sensors have the capability of being calibrated to Brix (Dissolved solids). For a Brix calibration a different type of line is used using the equation:

$$\text{Brix} = A - B \cdot e^{\left(\frac{C \cdot us}{100000}\right)} + \frac{D \cdot us^2}{1000}$$

For more information on calibrations and determining the correct calibration to use contact the Hydronix Support Department at [support@hydronix.com](mailto:support@hydronix.com).



### 3 SSD Coefficient and SSD Moisture Content

In practice it is only possible to obtain oven dried moisture (total moisture) values for calibration. If the surface moisture content (free moisture) is required, the Saturated Surface Dry (SSD) coefficient must be used. In some industries SSD is also known as the Water Absorption Value (WAV).

$$\text{Absorbed moisture} + \text{Free moisture} = \text{Total moisture}$$

The SSD coefficient used in Hydronix procedures and equipment is the Saturated Surface Dry offset, which is the water adsorption value of the material. The SSD value can be determined using industry standard procedures or obtained from the material supplier.

The surface moisture content refers **only** to the moisture on the surface of the aggregate, i.e. the 'free water'. In certain applications such as concrete production only this surface water is used in the process, which is why it is this value that is generally referred to in concrete mix designs.

$$\text{Oven dried moisture \% (Total)} - \text{water adsorption value \% (SSD offset in the sensor)} = \text{surface moisture \% (free moisture)}$$

### 4 Storing Calibration Data

There are two ways of storing the calibration data, either in the control system or in the sensor. Both methods are shown below.

Calibration inside the sensor will involve updating the coefficient values using the digital RS485 interface. A value that is directly proportional to moisture will then be output by the sensor. To communicate using the RS485 interface, Hydronix have several PC utilities, most notably Hydro-Com which contains a dedicated material calibration page.

To calibrate outside of the sensor, the control system will require its own calibration function, and the moisture conversion can then be calculated using the linear Unscaled output from the sensor. For guidance on setting the output see Figure 2.

#### 4.1 Calibration inside the Sensor

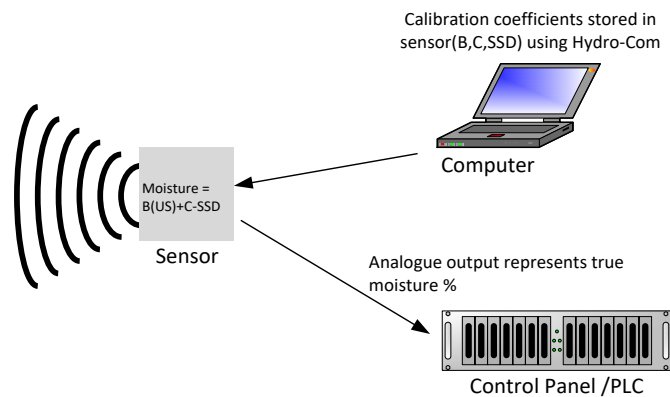

Figure 16: Calibration inside the Sensor

When calibrating the sensor using the latest versions of Hydro-Com or Hydro-View, Unscaled values are stored for each measurement mode for each calibration point. This means that once a valid calibration has been conducted, a correct moisture value for each mode is always available. The sensor therefore stores a set of A, B, C and D coefficients for each mode.

The advantages of calibrating inside the sensor are:

- Advanced free software improving calibration accuracy, including diagnostics software.
- Control system does not need modification to calibrate the sensor.
- Calibrations can be transferred between sensors.

## 4.2 Calibration inside the Control System

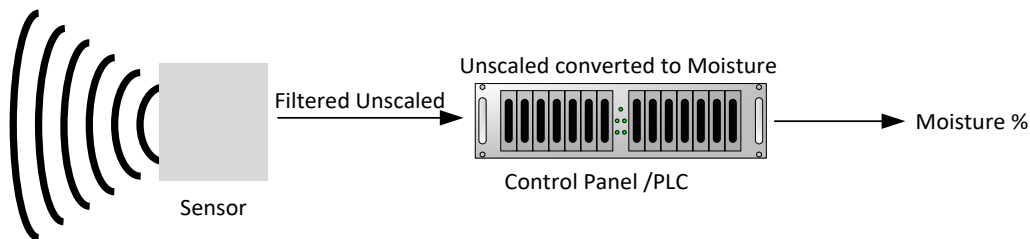

**Figure 17: Calibration inside the Control System**

The advantages of calibrating inside the control system are:

- Direct calibration without the need for an additional computer or RS485 adapter.
- No need to learn how to use additional software.
- If it is necessary to replace the sensor, a replacement Hydronix sensor can be connected, and valid results obtained immediately without connecting the sensor to a PC to update the material calibration.
- Calibrations can be switched between sensors easily.

## 5 Calibration Procedure for Flowing Material (Linear)

To determine the calibration line, at least two points are required. Each point is derived by flowing material over the sensor and finding the sensor's Unscaled reading. At the same time, a sample of the material should be taken and dried to find its true moisture content. This gives 'Moisture' and a corresponding 'Unscaled' which can be plotted on a graph. With at least two points, a calibration line can be drawn.

The following procedure is recommended when calibrating the sensor to the material. This procedure uses the Hydro-Com utility, and the calibration information is stored inside the sensor. Full details of the calibration process are contained in the Hydro-Com User Guide HD0682.

Whether the calibration data is stored within the sensor or the control system, the process is the same.

There are international standards for testing and sampling that are designed to ensure that the moisture content derived is accurate and representative. These standards will define accuracy of weighing systems and sampling techniques to make the samples representative of the flowing material. For more information on sampling please refer to your standard or contact Hydronix at [support@hydronix.com](mailto:support@hydronix.com).

## 5.1 Hints and Safety

- Wear safety glasses and protective clothing to guard against expulsion of material during the drying process.
- Do not attempt to calibrate the sensor by packing material on the face. The readings obtained will not be representative of those from a real application.
- Whilst recording the sensor Unscaled output, always sample where the sensor is located.
- Never assume that material flowing out of two gates in the same bin is the same moisture content and do not attempt to take samples from the flow in both gates to get an average value – always use two sensors.
- Where possible, average the sensor's readings either in the sensor using the digital input, or inside the control system.
- Ensure the sensor sees a representative sample of material.
- Ensure a representative sample of material is taken for moisture testing.

## 5.2 Equipment

- *Weighing scales* – to weigh up to 2kg, accurate to 0.1g
- *Heat source* – for drying samples, such as an oven, microwave or moisture balance.
- *Container* – with re-sealable lid for storing samples.
- *Polythene bags* – for storing samples prior to drying.
- *Scoop* – for collecting samples.
- *Safety equipment* – including glasses, heat resistant gloves and protective clothing.

## 5.3 Handling Collected Material Samples

To create an accurate calibration it is necessary to collect samples of the material as it passes over the sensor and, at the same time, record the Average Unscaled value from the sensor during the material collection period. To ensure the material collected is accurately analysed to determine the moisture content, it is imperative that the material is collected as close to the sensor as possible and sealed in an airtight container/bag immediately after collection. If the material is not sealed in an airtight container/bag moisture will be lost before it is analysed. The container/bag must only be opened when the laboratory tests are to be performed.

If collecting hot material (i.e. from the outlet of a dryer or in hot environments) the material **MUST** be sealed into the container/bag and allowed to cool to room temperature before it is analysed. Once it has cooled the container/bag must be shaken to enable any moisture on the surface of the container to be mixed back into the material. Removing the material before it has cooled will result in moisture loss due to evaporation and will introduce potential errors to the calibration.

**NOTES: For full instructions on using Hydro-Com, refer to the Hydro-Com User Guide (HD0682). Record all calibration data including suspected erroneous results.**

***The same principles apply with or without using Hydro-Com when calibrating.***

## 5.4 Procedure

1. To perform the calibration, it is essential that the averaged Unscaled value is recorded as the material is passing the sensor. At the same time a sample of the material needs to be collected. Samples should be taken as close to the sensor as possible this will ensure that the sample collected is a true representation of the material the sensor was measuring.
2. To perform the calibration the Average Unscaled value must be obtained. This is done by either triggering the Average/Hold input by applying 24vDC to the digital input or manually selecting "Start Averaging" using a button in the Hydro-Com software or on the Hydro-View screen.

Installing the averaging switch close to the material sampling port will achieve more precise correlation between the sensor's average value and the moisture value of the collected material sample.

The optimum installation is one where the digital input is wired into the control system, so it is triggered automatically at the same time as the material is being discharged.

For a bin/hopper installation this means that, when the bin/hopper gate opens, averaging will start and when closed the averaging will stop the value will be held until the averaging is started again. Averaging must be triggered by the main dose of material; any jogging of material should not activate the sensor digital input.

3. Once the material has started to flow consistently the averaging should start. Collect at least 10 sample increments from the flow to yield a bulk sample of at least 5kg<sup>1</sup> of material in the container. The material **MUST** be collected at a position close to the sensor so that the sensor reading relates to the batch of material that has been collected.
4. Stop the material flow. Record the Average Unscaled value from the sensor.
5. Thoroughly mix the collected sample to create a homogenous mix. This sample should be sealed in an airtight bag and kept out of the sun until it is ready to be analysed. It is particularly important that the moisture in the sample is not allowed to escape.
6. Take 3x1kg samples of the material collected and perform a laboratory test on each. Ensure all moisture is removed. Organic materials that have larger particles larger particles, such as grains, seeds, pulses, and pellets, may require grinding before drying, see the appropriate industrial standards for the material for more details.
7. All three samples should be completely dried, and the results compared. Use the moisture calculator to calculate the moisture %, (see section 5.5). If the results differ by more than 0.3% moisture, then the samples should be discarded, and the calibration process repeated. This can indicate an error in the sampling process or the lab tests.
8. Use the average moisture of the three samples to correlate to the Average Unscaled value.
9. This process should be repeated for additional calibration points. Ideally calibration points should be collected that represent the full working moisture range of the material.

**For instructions on how to calibrate using Hydro-Com see the Hydro-Com user guide document number HD0682**

**Note 1) Standards for testing aggregates recommend that for representative sampling, at least 20kg of bulk material is required (0-4mm material)**

**Note 2) Standards for testing aggregates recommend that for representative sampling, the difference in moisture should be no greater than 0.1%.**

## 5.5 Calculating the Moisture Content

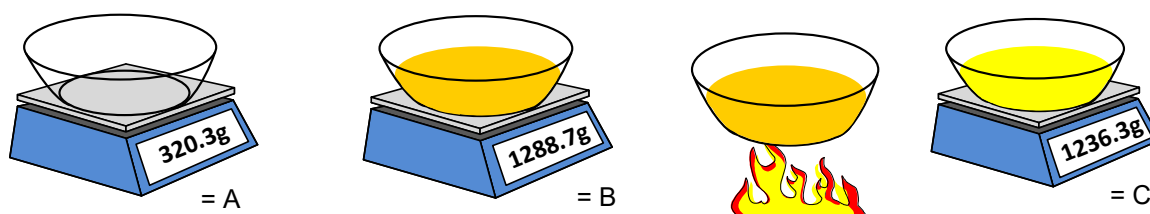

$$\text{Moisture Content} = \frac{(B-C)}{(C-A)} \times 100\%$$

Example

$$\text{Moisture Content} = \frac{1288.7\text{g} - 1236.3\text{g}}{1236.2\text{g} - 320.3\text{g}} \times 100\% = 5.7\%$$

**(Note that moisture calculated in this example is based upon the dry weight.)**

## 6 Linear Calibration

A good calibration is made by analysing samples and taking readings over the full working moisture range of the material. As many points as practical should be made as more points provide higher accuracy. The graph below shows a good calibration with high linearity.

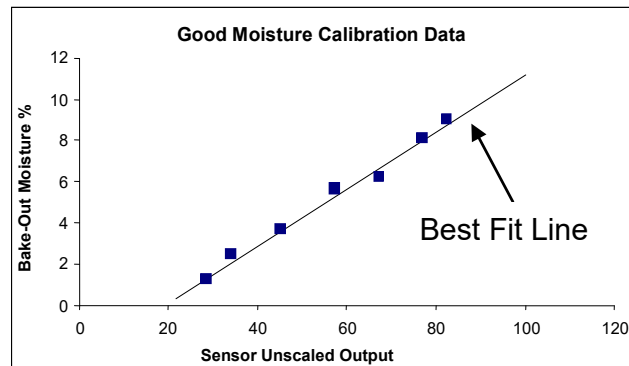

Figure 18: Example of Good Material Calibration

### 6.1 Calibration Inaccuracy is Likely to Result If:

- Too small a sample of material is used for measuring the moisture content.
- A small number of calibration points are used (for example 1 or 2 points).
- The sub-sample tested is not representative of the bulk sample.
- Samples are taken close to the same moisture content (Figure 19, left). A good range is necessary.
- There is a large scatter in the readings as shown in the calibration graph Figure 19 (right). This generally implies an unreliable or inconsistent approach to taking samples for oven drying or poor sensor positioning with inadequate material flow over the sensor.
- If the averaging facility is not used to ensure representative moisture reading for the entire batch.

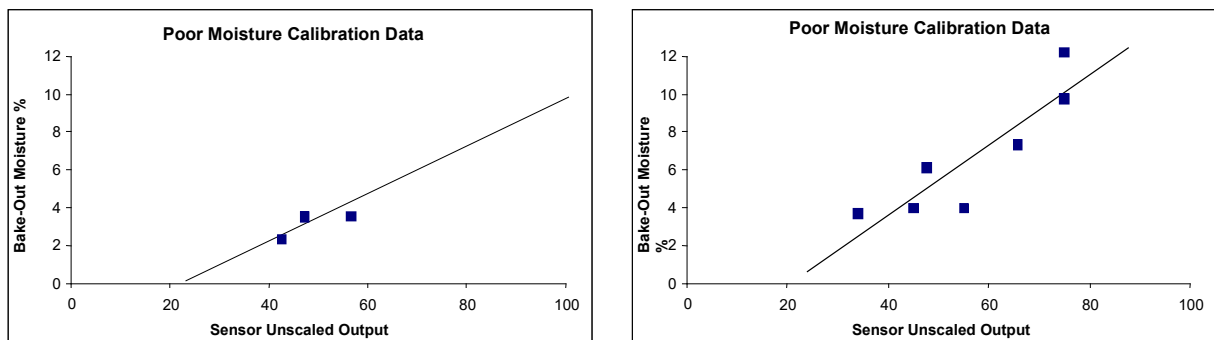

Figure 19: Examples of Poor Material Calibration Points

## 7 Quadratic Calibration

Hydronix Microwave Moisture sensors can use a quadratic calibration function for use in the rare occasions where a material is non-linear. For quadratic calibrations, where the calibration points do not form a straight line the 'A' coefficient is utilised and a best fit curve is generated (Figure 20). The equation used is show below:

$$\text{Moisture \%} = A \times (\text{Unscaled value})^2 + B (\text{Unscaled value}) + C - D$$

The same procedure is used for linear calibrations (see Page 34) and should be followed to collect samples and to determine the moisture % of the material.

Full details of the calibration process are contained in the Hydro-Com User Guide HD0682.

## 7.1 Good/Bad Quadratic Calibrations

A good calibration is made when the calibration samples are taken over the working range of the material. As many points as possible should be taken to provide higher accuracy.

Figure 20 is an example of a good calibration. All the points are close to the curve and there is a good spread in the points covering the full moisture range of the material.

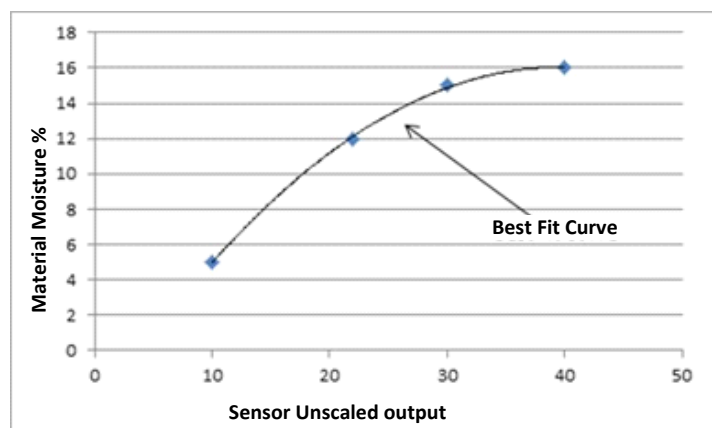

Figure 20: Example of a Good Quadratic Calibration

Figure 21 is an example of a poor calibration. It is evident that the calibration points are not close to the curve fit and this indicates that there are possible sampling and laboratory errors. This calibration would need to be completed again.

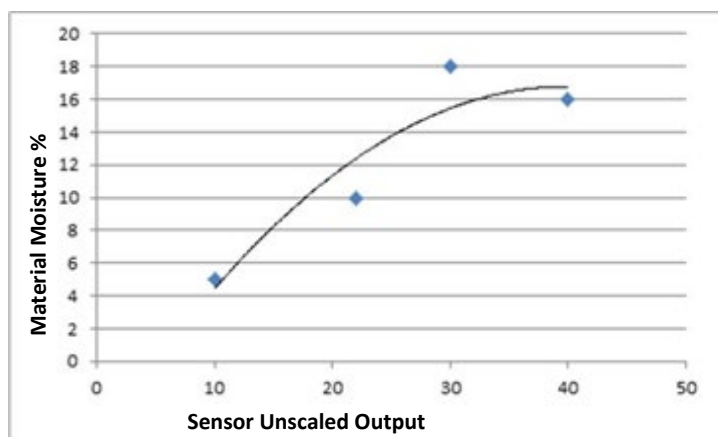

Figure 21: Example of a Bad Quadratic Calibration

## 8 Calibrating a sensor in a mixer

When a sensor has been installed in a mixer, with multiple materials, and it is required to output moisture % it is not always possible to perform a standard calibration process. This is especially true in concrete production. Taking samples of the finished wet concrete and performing a bake-

out to determine the moisture % is not reliable due to the chemical reactions and safety issues. The following method can be used to calibrate in these situations.

1. To calibrate in the mixer the moisture % of all the dry materials must be calculated using a suitable calibrated moisture sensor or by using laboratory facilities.

In this example the dry mix material moistures and weights are:

Sand = 950kg at 8% moisture

Gravel = 1040kg at 2.5% moisture

Cement = 300kg at 0% moisture (Should always be 0%)

2. To determine the water in the material the dry weight must be calculated using the following equation:

$$\text{Dry weight} = \frac{\text{Wet Weight}}{(1 + \text{Moisture \%})} \quad (\text{Moisture \%: } 1=100\%, 0.1 = 10\%)$$

$$\text{Sand} \quad \frac{950}{1.08} = 879.63\text{kg}$$

$$\text{Stones} \quad \frac{1040}{1.025} = 1014.63\text{kg}$$

$$\text{Cement} \quad \frac{300}{1} = 300\text{kg}$$

$$\text{Total dry weight} = 879.63 + 1014.63 + 300 = \mathbf{2194.26\text{kg}}$$

3. Calculate the water in the material:

Water Content = Wet weight – Dry weight

$$\text{Sand} = 950 - 879.63 = 70.37 \text{ kg}$$

$$\text{Stones} = 1040 - 1014.63 = 25.37 \text{ kg}$$

$$\text{Cement} = 300 - 300 = 0 \text{ kg}$$

$$\text{Total water} = 70.37 + 25.37 + 0 = \mathbf{95.74\text{kg}}$$

4. The dry weight and the water content are then used to calculate the moisture % of the material:

$$\text{M\%} = \frac{\text{Total water}}{\text{Dry weight of material}} \times 100$$

$$\text{M\%} = \frac{95.74}{2194.26} \times 100 = \mathbf{4.36\%}$$

5. To create a calibration, point the dry material must be loaded into the mixer and mixed thoroughly until the sensor signal is stable, this indicates that the mix is homogenous. Once the signal is stable, record the sensors Unscaled value. In this example the value was 35 Unscaled.
6. To create a second calibration point, add a set amount of water to the mixer, in this example 35 litres is added. Thoroughly mix the material until the sensor signal is again stable. Record the sensors Unscaled value, in this example it is 46 Unscaled.
7. Calculate the moisture % of the wet mix using the following equation:

Total water = Dry material water + Added water

$$\text{Total water} = 95.74 + 35 = 130.74 \text{ litres}$$

$$\text{Moisture \%} = \frac{\text{Total water}}{\text{Dry weight of the material}} \times 100$$

$$\text{Moisture \%} = \frac{130.74}{2194.26} \times 100 = \mathbf{5.96\%}$$

8. The Unscaled values and Moisture % from the dry and wet mixes are used to create the calibration.

The calibration data for the mix is:

MOISTURE %	Unscaled
4.36	35
5.96	46

9. The calibration data can be entered into Hydro-Com or excel to calculate the calibration coefficients. This can also be done manually using the following equations:

$$B \text{ (Gradient)} = \frac{\text{Moisture (Wet)} - \text{Moisture (Dry)}}{\text{Unscaled (Wet)} - \text{Unscaled (Dry)}}$$

$$B = \frac{5.96 - 4.36}{46 - 35}$$

$$B = \frac{1.6}{11}$$

$$\mathbf{B = 0.145}$$

$$\text{Moisture \%} = B \times \text{Unscaled} + C$$

$$\therefore C \text{ (offset)} = \text{Moisture \%} - (B \times \text{Unscaled})$$

Using the wet mix values:

$$C = 5.96 - (0.145 \times 46)$$

$$C = 5.96 - 6.67$$

$$\mathbf{C = -0.71}$$

10. If the B and C values are loaded into the sensor the output can be configured to Moisture%. Using the B and C values in this example if the Unscaled value is 58:

$$\text{Moisture \%} = 0.145 \times 58 - 0.71$$

$$\text{Moisture \%} = 7.7\%$$

If the recipe and material proportioning remain the same the calibration will be valid.

## 9 Brix Calibration

Selected sensors can derive the Brix content of a liquid from the Unscaled value (See the Technical Specification in each Sensor's Installation Guide for more information). This is a measure of the dissolved solids present in a liquid and is often used in the food industry.

The Brix calculation is different from the linear calculation used for moisture. To create a calibration line the following equation is used:

$$\text{Brix} = A - B \cdot e^{\left(\frac{C \cdot us}{1000000}\right)} + \frac{D \cdot us^2}{1000}$$

where 'us' is the Unscaled value from the sensor. This equation gives an exponential curve.

When using the sensors to measure Brix, the sensor must still be calibrated to the process being monitored. The process followed is:



1. To calibrate the sensor, several Unscaled values need to be correlated to their corresponding Brix value.
2. To perform the calibration the Filtered Unscaled value is recorded and at the same time a sample of the material is collected. This sample should be taken as close to the sensor as possible. This will ensure that the material collected is a true representation of what the sensor was measuring.
3. When a calibration sample is required ensure, the material is flowing in the process. Record the Filtered Unscaled value from the sensor and at the same time collect the material sample using an appropriate sampling method.
4. The sample should be large enough to enable several laboratory tests to be performed. The results from the laboratory should be compared as variations in the results will indicate errors in the sampling or the laboratory process.
5. The average of the laboratory results and the Filtered Unscaled value make up one calibration point.
6. Steps 3-5 should be repeated for additional calibration points. Ideally calibration points should be collected to cover the entire expected Brix range of the material.

Hydro-Com software should be used to calculate the calibration coefficients and to update the sensor with the calibration.

## 9.1 Good/Bad Brix Calibration

A good Brix calibration is achieved by analysing the material over the working range. A good spread of points is necessary to provide higher accuracy.

Figure 22 shows a good calibration with all points close to the best fit curve.

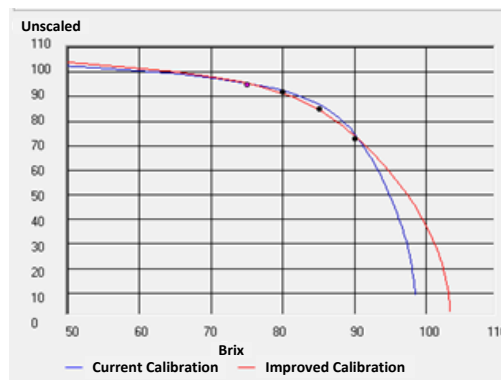

**Figure 22: Example of a Good Brix Calibration**

Figure 23 is an example of a bad Brix calibration, this is evident as the points are not all close to the best fit curve.

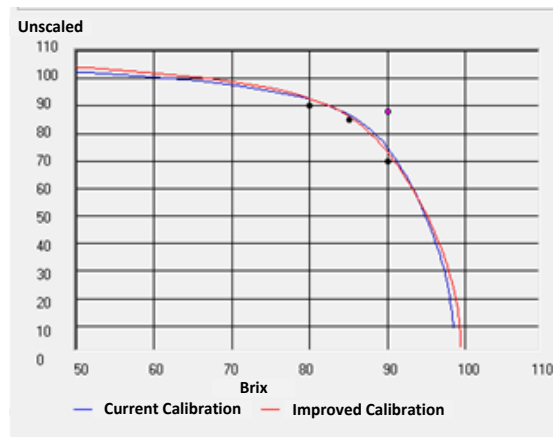

**Figure 23: Example of a Bad Brix Calibration**

For full details on the use of Hydro-Com see user guide HD0682.

The sensor is a precise instrument and in many cases is more accurate than other equipment or sampling techniques used for calibration purposes. For best performance ensure that the installation follows the basic guidelines below and that the sensor is configured with suitable filtering parameters.

It may also be beneficial to adjust the sensor filtering and signal smoothing parameters as described in Chapter 2 Section 5.

Selecting an alternative measurement mode (Chapter 2 Section 8) may give a more desirable signal response but before doing so the performance of each mode should be monitored using the Hydro-Com software.

## 1 General to all Applications

- **Power Up:** It is recommended to allow the sensor to stabilise for 15 minutes after applying power before use.
- **Positioning:** The sensor should be in contact with a representative sample of the material.
- **Flow:** The sensor should be in contact with a consistent flow of material.
- **Material:** If the material type or source changes this may affect the moisture reading.
- **Material particle size:** If the particle size of the material being measured changes this may affect the rheology of the material for the same moisture content. Increased fine material often leads to a 'stiffening' of the material for the same moisture content. This 'stiffening' should not automatically be regarded as a reduction in moisture. The sensor will continue to measure moisture.
- **Material buildup:** Avoid material build up on the Ceramic faceplate.

## 2 Routine maintenance

Ensure that the ceramic measurement faceplate is always free from build-up of material.

Inspect the ceramic face plate for any signs of cracks or chips to the surface.



***DO NOT HIT THE CERAMIC FACEPLATE DURING MAINTENANCE***



The following tables list the most common faults found when using the sensor. If you are unable to diagnose the problem from this information, please contact Hydronix technical support.

## 1 Sensor Diagnostics

### 1.1 Symptom: No output from Sensor

Possible explanation	Check	Required result	Action required on failure
Output is working but not correctly	Perform simple test with hand on sensor	Milliamp reading within the normal range (0-20mA, 4-20mA)	Power down and re-power sensor
No power to sensor	DC power at junction box	+15Vdc to +30Vdc	Locate fault in power supply/wiring
Sensor has temporarily locked up	Power down and re-power sensor	Sensor functions correctly	Check power
No sensor output at control system	Measure sensor output current at control system	Milliamp reading within the normal range (0-20mA, 4-20mA). Varies with moisture content	Check cabling back to junction box
No sensor output at junction box	Measure sensor output current at terminals in junction box	Milliamp reading within the normal range (0-20mA, 4-20mA). Varies with moisture content	Check sensor connector pins
Sensor MIL-Spec connector pins are damaged	Disconnect the sensor cable and check if any pins are damaged	Pins are bent and can be bent to normal to make electrical contact	Check sensor configuration by connecting to a PC
Internal failure or incorrect configuration	Connect the sensor to a PC using the Hydro-Com software and a suitable RS485 converter	Digital RS485 connection is working. Correct the configuration	Digital RS485 connection is not working. Sensor should be returned to Hydronix for repair.

## 1.2 Symptom: Incorrect Analogue Output

Possible explanation	Check	Required result	Action required on failure
Wiring problem	Wiring at the junction box and PLC	Twisted pairs used for complete length of cable from sensor to PLC, is correctly wired	Wire correctly using specified cable in the technical specification
Sensor's analogue output is faulty	Disconnect the analogue output from the PLC and measure with an ammeter	Milliamp reading within the normal range (0-20mA, 4-20mA)	Connect sensor to a PC and run Hydro-Com. Check analogue output on the diagnostics page. Force the mA output to known value and check this with an ammeter
PLC analogue input card is faulty	Disconnect the analogue output from the PLC and measure the analogue output from the sensor using an ammeter	Milliamp reading within the normal range (0-20mA, 4-20mA)	Replace analogue input card

## 1.3 Symptom: Computer Does Not Communicate with the Sensor

Possible explanation	Check	Required result	Action required on failure
No power to sensor	DC power at junction box	+15Vdc to +30Vdc	Locate fault in power supply/ wiring
RS485 incorrectly wired into converter	Converter's wiring instructions and A and B signals are the correct orientation.	RS485 converter correctly wired	Check PC Com port settings
Incorrect serial Com Port selected on Hydro-Com	Select correct Com Port on Hydro-Com.	Switch to the correct Com Port	Determine the Com Port number assigned to the actual port by looking at the PC device manager
More than one sensor has the same address number	Connect to each sensor individually	Sensor is found at an address. Renumber this sensor and repeat for all the sensors on the network	Try an alternative RS485-RS232/USB if available

## 1.4 Symptom: Near Constant Moisture Reading

Possible explanation	Check	Required result	Action required on failure
Empty bin or sensor uncovered	Sensor is covered by material	100mm minimum depth of material	Fill the bin
Material stuck in bin	Material is not stuck above sensor	Smooth flow of material over the sensor face when the gate is open	Look for causes of erratic flow. Reposition sensor if problem continues
Build-up of material on sensor face	Signs of build-up such as dried solid deposit on ceramic face	Ceramic faceplate should be kept clean by the action of material flow	Check angle of the ceramic in range of 30° to 60°. If problem continues reposition sensor.
Incorrect input calibration within control system	Control system input range	Control system accepts output range of sensor	Modify control system, or reconfigure sensor
Sensor in alarm condition – 0mA on 4-20mA range	Moisture content of material by oven drying	Must be within working range of sensor	Adjust sensor range and/or calibration
Interference from mobile phones	Use of mobile phones close to sensor	No RF sources operating near to sensor	Prevent use within 5m of sensor
Average/Hold switch has not operated	Apply signal to digital input	Average moisture reading should change	Verify with Hydro-Com diagnostics
No power to sensor	DC power at junction box	+15Vdc to +30Vdc	Locate fault in power supply/ wiring
No sensor output at control system	Measure sensor output current at control system	Varies with moisture content	Check cabling back to junction box
No sensor output at junction box	Measure sensor output current at terminals in junction box	Varies with moisture content	Check sensor output configuration
Sensor has shut down	Disconnect power for 30 seconds and retry or measure current drawn from power supply	Normal operation is 70mA – 150 mA	Check operating temperature is within specified range
Internal failure or incorrect configuration	Remove sensor, clean ceramic face with water and dry afterwards then check reading (a) with ceramic face clean and (b) with	Reading should change over a reasonable range	Verify operation with Hydro-Com diagnostics

	hand pressed firmly on ceramic face.		
--	--------------------------------------	--	--

### 1.5 Symptom: Inconsistent or Erratic Readings That Do Not Track Moisture Content

Possible explanation	Check	Required result	Action required on failure
Debris on sensor	Debris, such as cleaning rags hanging over sensor face	The sensor must always be kept clear of debris	Improve material storage. Fit wire mesh grids to tops of bins and mixer loading ports.
Material 'stuck' in bin	Material is stuck above sensor	A smooth flow of material over the face of the sensor when gate is open	Look for causes of erratic flow of material. Reposition sensor if problem continues
Build-up of material on sensor face	Signs of build-up such as dried solid deposit on ceramic face	Ceramic face should always be kept clean by the action of the material flow	Change angle of the ceramic in range 30° to 60°. Reposition sensor if problem continues
Inappropriate calibration	Ensure calibration values are appropriate to working range	Calibration values spread throughout range avoiding extrapolation	Perform further calibration measurements
Ice forming in material	Material temperature	No ice in material	Sensor will not measure in ice
Average/Hold signal is not in use	Control system is calculating batch average readings	Average moisture readings must be used in batch weighing applications	Modify control system and/or reconfigure sensor as required
Incorrect use of Average/Hold signal	Average/Hold input is operating during the main flow of material from the bin	Average/Hold should be active during main flow only – not during jogging period	Modify timings to include main flow and exclude jogging from measurement.
Inappropriate sensor configuration	Operate the Average/Hold input. Observe sensor behaviour	The output should be constant with Average/Hold input OFF and changing with the input ON	Sensor output configured correctly for the application
Inadequate ground connections	Metalwork and cable ground connections	Ground potential differences must be minimised	Ensure equipotential bonding of metalwork



## 1.6 Sensor Output Characteristics

	Filtered Unscaled Output (values shown are approximate)			
	RS485	4-20mA	0-20 mA	0-10 V
Sensor exposed to air	0	4 mA	0 mA	0V
Hand on sensor	75-85	16-17.6 mA	15-17 mA	7.5-8.5 V



Q: *Hydro-Com does not detect any sensors*

A: If there is more than one sensor connected on the RS485 network, ensure that each sensor has a different address. Ensure the sensor is correctly connected, that it is powered from a suitable 15-30Vdc source and the RS485 wires are connected through a suitable RS232-485 or USB-RS485 converter to the PC. On Hydro-Com ensure the correct COM port is selected.

Q: *How often should I calibrate the sensor?*

A: Recalibration is not necessary unless the gradation of the material changes significantly or a new material source is used. However it is a good idea to take samples (see Introduction to Material Calibration on Page 31) regularly on site to confirm the calibration is still valid and accurate. Put this data in a list and compare them with the results of the sensor. If the points lie near to or on the calibration line, then the calibration is still good. If there is a continuous difference you must recalibrate.

Q: *If I must replace the sensor, do I have to calibrate my new sensor?*

A: Normally no, assuming the sensor is mounted in the same position. Copy the calibration data for the material to the new sensor and the moisture readings will be the same. It would be wise to verify the calibration by taking a sample as shown in Introduction to Material Calibration on Page 31, and checking this calibration point. If it lies near to or on the line, then the calibration is still good.

Q: *What should I do if there is minor variation of moisture in my material on the day I calibrate?*

A: For sand only (HP04 only)

If you have dried different samples and there is minor variation in moisture (1-2%), then settle for one good calibration point by averaging the Unscaled readings and oven dried moistures. Hydro-Com will allow you to produce a valid calibration until further points can be made. When the moisture changes by at least 2% then sample again and enhance the calibration by adding more points.

Q: *If I change the type of material I am using, do I need to recalibrate?*

A: Yes, you must calibrate to each type of material.

Q: *Which output variable should I use?*

A: This depends on whether the calibration is stored in the sensor or the batch controller, and if the digital input is used for batch averaging. Refer to Analogue Output Setup on page 15 for more information.

Q: *There seems to be a scatter in the points I have made in my calibration, is this a problem and is there something I can do to improve the calibration result?*

A: If you have a scattering of points through which you are trying to fit a line, then there is a problem with your sampling technique. Ensure the sensor is mounted properly in the flow. If the sensor position is correct and the sampling is done as explained on Page 34 then this should not happen. Use an 'Average Unscaled' value for your calibration. The averaging period can be set either with the 'Average/Hold' input or using 'Remote Averaging'. See Hydro-Com User Guide (HD0682) for more information.

**Q:** *The sensor readings are changing erratically and are not consistent with the changes in moisture in the material. Is there a reason for this?*

**A:** It is possible that some material is building up on the sensor face during the flow. With a build-up even if there is a change in the moisture, the sensor only 'sees' the material in front of it causing the reading to stay reasonably constant. The reading might remain constant until the build-up is dislodged, allowing the new material to flow over the sensor face. This would cause a sudden change in the readings. To check if this is the case, try hitting the sides of the bin/silo to knock off any fouling material and see if the readings change. Also, check the mounting angle of the sensor. The ceramic should be mounted at an angle which allows material to pass continuously over the sensor face plate. Bin mounted sensors have two lines on the rear plate label that indicate the angle that the sensor should be installed in relation to the material flow. Correct alignment is where either line is in line with the material flow, indicating that the ceramic is at the correct angle.

**Q:** *Does the angle of the sensor affect the reading?*

**A:** It is possible that changing the angle of the sensor can affect the readings. This is due to a change in compaction or density of the material flowing past the measurement face. In practice, slight changes in the angle will have a negligible effect on the readings, but a substantial change in the mounting angle (>10 degrees) will affect the readings and ultimately the calibration will become invalid. For this reason, it is essential that when removing a sensor or replacing it, the same angle is maintained.

**Q:** *Why does the sensor output negative moisture when the bin is empty?*

**A:** The Unscaled output for air will be less than the Unscaled reading for 0% moisture of the material; hence the moisture output will read negative.

**Q:** *What is the maximum length of cable I can use?*

**A:** See the relevant sensor installation guide for full technical specifications.

## 1 Document Cross Reference

This section lists all the other documents that are referred to in this User Guide. You may find it beneficial to have a copy available when reading to this guide.

Document Number	Title
HD0682	Hydro-Com User Guide
HD0675	Hydro-Probe and Hydro-Probe XT Installation Guide
HD0676	Hydro-Mix Installation Guide
HD0677	Hydro-Probe Orbiter Installation Guide
HD0678	Hydronix Moisture Sensor Electrical Installation Guide
EN0077	Moisture Control Methods for Batching
EN0078	Integrating Hydro-Mix and Hydro-Probe Sensors in a Grain Duct
EN0079	HP04 Sensor Factory Default Parameters
EN0080	XT02 Sensor Factory Default Parameters
EN0081	HM08 Sensory Factory Default Parameters
EN0082	ORB3 Sensor Factory Default Parameters
HD0881	Hydronix Microwave Moisture Sensor Modbus RTU Protocol Register Mapping



## Index

Alarms		Free Moisture .....	33
Alarm Mode .....	19	High Limit .....	See Alarms
High Limit .....	19	Hydro-Com.....	15, 51
Low Limit .....	19	Low Limit.....	See Alarms
Analogue Output .....	13, 15	Measurement Modes .....	25
Auto-Track.....	18	Measurement Technique .....	13
Average Unscaled.....	16	Moisture	
Average/Hold .....	17	Negative .....	52
Averaging Parameters .....	19	Surface .....	33
Bin Empty .....	19	Moisture content .....	36
Brix .....	40	Moisture/Temperature.....	17
Calibration .....	51	Output .....	15
Brix .....	40	Parameters	
Data Storing .....	33	Averaging .....	19
Good/Bad Brix Calibration.....	41	Raw Moisture .....	20
Good/Bad Linear Calibration .....	37	Raw Unscaled.....	20
Good/Bad Quadratic Calibrations .....	38	Samples	
In Control System .....	34	International Standards .....	36
Inside a Mixer .....	38	Saturated Surface Dry .....	See SSD
Inside Sensor .....	34	Secondary Protocol	
Procedure .....	34	Modbus Configuration .....	29
Configuration .....	13	Slew Rate Filters .....	20
Data Invalid .....	19	Smoothing Time .....	21
Digital Inputs/Output.....	17	SSD.....	33
Filtered Signal .....	24	Total Moisture .....	33
Filtering.....	20	Water Absorption Value .....	33
Filtering Time .....	20, 21		
Filters			
Slew Rate .....	20		